

# Datasheet ESCP-BMS1

MEMS Capacitive Pressure & Temperature Sensor for gases.

- State of the art performance due to MEMS capacitive technology
- Outstanding overpressure tolerance (up to 100x)
- Absolute, differential, gauge operation
- Full scale pressure sensor options from 10 mbar to 11000 mbar
- Temperature sensor: -20°C to +85°C
- Calibrated & temperature compensated output
- I<sup>2</sup>C, SPI or analog interface
- Excellent accuracy, resolution, long term stability
- Low power consumption
- No external components required

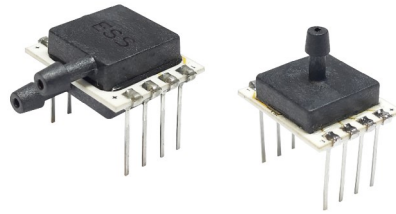

## Product Summary

ES Systems has developed a series of board mountable pressure sensors targeting a variety of markets requiring high resolution and accuracy for absolute, gauge or differential pressure measurements. The ESCP-BMS1 is a MEMS capacitive pressure sensor with state-of-the-art performance. The MEMS pressure sensor die is underpinned by ES' innovative SOI-surface micromachining technology.

ESCP-BMS1 is an absolute, gauge or differential pressure sensor of ultra high resolution with analog, SPI or I<sup>2</sup>C interface. The output is fully calibrated, and temperature compensated based on the internal temperature sensor and the factory calibration coefficients which are stored in the embedded memory. The sensor is ready to be installed directly to the end system without further processing. The total error including repeatability, hysteresis, non-linearity, thermal offset and calibration error between 0°C and 60°C is better than 0.25% FS.

Different power modes are available enabling low power operation. The sensor can be configured to provide both high accuracy 32-bit pressure and temperature outputs.

ESCP-BMS1 is a silicon capacitive pressure sensor with excellent long-term stability. The sensor is incorporated in a standard 8-pin DIP package with a single or two pneumatic ports. The top port is the high side and the bottom port is the low side.

## Typical Applications

### Industrial

Air Flow Measurement • Air Compressors • Air Movement Control • Actuators • Analytical Instruments • Automated Pneumatic Assembly Equipment • Chemical Analysis Controllers • Factory Automation • Fire Suppression System • Flow Calibrators Gas Chromatography • Gas Flow Instrumentation • Gaseous Leak Detection • Industrial Controls • Industrial Gas Supply • Industrial Pneumatic Devices • Leak Detection • Modulated Furnace Controls • Oxygen Concentrators • Panel Meters • Pressure Switching • Pressure Valves • Process Control Pumps • Remote Monitoring Devices • Robotics • Valves • Vacuum Pump Monitoring • Variable Air Volume (VAV) Control

### Medical

Anesthesia Equipment • Breathalyzers • CPAP Equipment • Drug Dosing Equipment • Hospital Beds • Hospital Gas Supply • Hospital Room Air Pressure • Massage Machines • Medical Instrumentation • Nebulizers • Patient Monitoring Equipment • Respiratory Equipment • Sleep Apnea Equipment • Spirometers • Ventilators • Wound Therapy

### HVAC

Airflow Monitoring • Clogged Filter Detection • Duct Air Flow • Environmental Control Systems • Filter Monitoring • Blocked Filter Detection • Indoor Air Quality

### 1. Total Error Band

Total Error Band (TEB) is a single specification that includes all possible sources of error in a pressure measurement. TEB should not be confused with accuracy, which is actually a component of TEB. TEB is the worst error that the sensor could experience. The TEB specification on a datasheet may be confusing. ES Systems uses the TEB specification in its datasheet because it is the most comprehensive measurement of a sensor's true accuracy. ES Systems also provides the accuracy specification in order to provide a common comparison with competitors' literature that does not use the TEB specification.

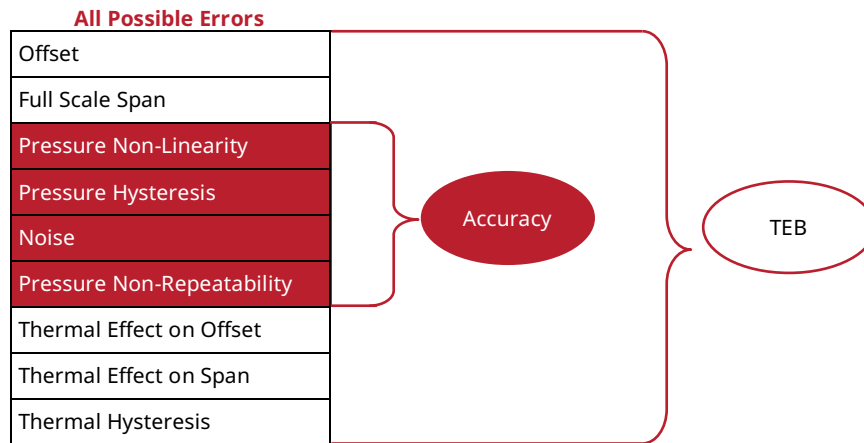

The figure below, illustrates the accuracy as well as the total error of the pressure measurement of ESCP-BMS1 sensors.

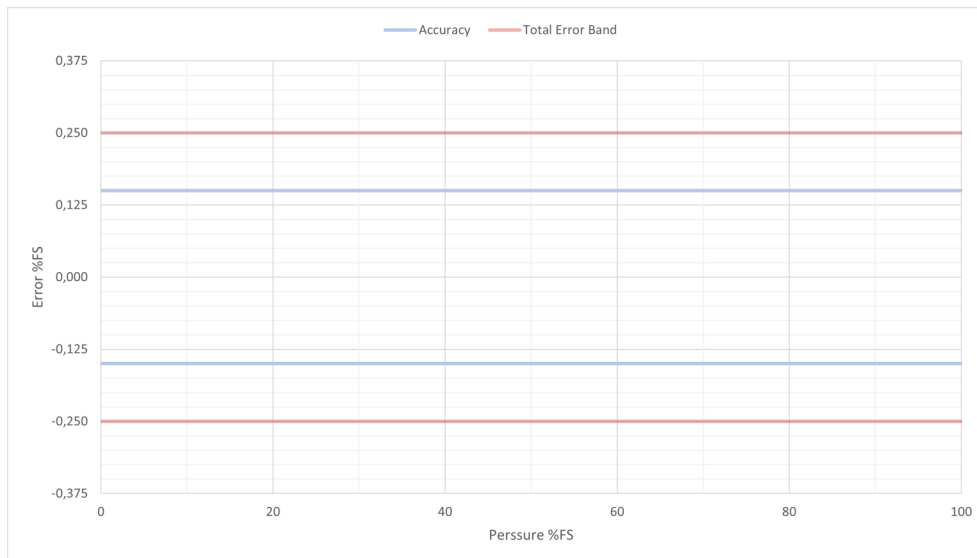

**Accuracy Performance**  
 FS range absolute: 0.5 to 10 bar  
 FS range gauge: 60 to 11000 mbar  
 FS range differential: ±50 to ±1000 mbar  
 0% FS to 100%FS = ±0.15%FS

**Total Error Band Performance**  
 FS range absolute: 0.5 to 10 bar  
 FS range gauge: 60 to 11000 mbar  
 FS range differential: ±50 to ±1000 mbar  
 0% FS to 100% FS = ±0.25%FS



## 2. Absolute Maximum Ratings<sup>1</sup>

Characteristic	Min.	Max.	Unit
Supply voltage ( $V_{supply}$ )	2.7	3.6	Vdc
Voltage on any pin	-0.3	3.6	V
Current on any pin	-	2	mA
Burst pressure	-	20 <sup>2</sup>	bara
Storage temperature	-20[-4]	+85[+185]	°C[°F]

<sup>1</sup> Absolute maximum ratings are the extreme limits the device will withstand without damage. The electrical and performance characteristics are not guaranteed as the maximum limits are approached, nor will the device necessarily operate as specified at absolute maximum ratings. Prolonged operation at absolute maximum ratings will degrade the device performance

<sup>2</sup> For sensors with FS pressure output < 1bara Burst pressure is 5bara

**CAUTION**  
**IMPROPER HANDLE**  
 Do not apply mechanical stress to the sensor.  
**Failure to comply with the instructions may result in product damage.**

**CAUTION**  
**PRODUCT DAMAGE**  
 Do not disassemble these products.  
**Failure to comply with the instructions may result in product damage.**

## 3. Operating Specifications

Characteristic	Min.	Typ.	Max.	Unit
Supply voltage ( $V_{supply}$ ) <sup>1</sup>	2.7	3.3	3.6	V
Supply current				
Continuous mode	-	-	0.5	mA
Sleep mode	-	-	0.1	
Output	Calibrated Pressure & Temperature			-
Output Interface	I <sup>2</sup> C, SPI, Analog			-
Digital bus frequency				
I <sup>2</sup> C	10	-	100	kHz
SPI	50	-	1000	
Analog Output Resistance	220k	-	-	Ohm
Start-up time <sup>2</sup>	-	30	-	msec
Operating temp. range	-20[-4]	-	+85[+185]	°C[°F]
Relative humidity (non-condensing)	-	-	95	% RH
I <sup>2</sup> C/SPI voltage Level				
Low	-	-	20	% $V_{supply}$
High	80	-	-	
Pull up on SDA / MISO / SCL / SCLK / SS	4.7	-	-	kOhm
Media Compatibility	Gases			-

<sup>1</sup>The sensor is not reverse polarity protected. Incorrect application of supply voltage or ground to the wrong pin may cause electrical failure.

<sup>2</sup>After 95% of  $V_{supply}$  reached.

#### 4. Sensor Pressure Types

Pressure Type	Description
Absolute	Output is proportional to the difference between applied pressure and vacuum pressure
Gauge	Output is proportional to the difference between applied pressure and ambient pressure
Differential	Output is proportional to the difference between the pressures applied to each port (P1 - P2)

#### 5. Pressure Sensor Specifications

Characteristic	Absolute			Gauge			Differential			Unit
	Min.	Typ.	Max.	Min.	Typ.	Max.	Min.	Typ.	Max.	
Pressure Range	200	-	10000	0	-	11000	-1000	-	1000	mbar
Comp. temp range <sup>1</sup>										
Option 01	0[32]	-	+60[+140]	0[32]	-	+60[+140]	0[32]	-	+60[+140]	°C[°F]
Option 02	-20[-4]	-	+85[+185]	-20[-4]	-	+85[+185]	-20[-4]	-	+85[+185]	
Effective Resolution										
Response Time (15Hz)	-	15	-	-	15	-	-	15 <sup>2</sup>	-	bits
Response Time (1KHz)	-	11	-	-	11	-	-	11 <sup>2</sup>	-	
Total Error Band <sup>3</sup>										
0 to +60°C	-	-	±0.25	-	-	±0.25	-	-	±0.25 <sup>4</sup>	%
-20 to +85°C	-	-	±0.35	-	-	±0.35	-	-	±0.35 <sup>4</sup>	FSS <sup>5</sup>
Accuracy <sup>6</sup>	-	-	±0.15	-	-	±0.15	-	-	±0.15 <sup>7</sup>	%FSS
Long term stability <sup>8</sup>	-	-	±0.25	-	-	±0.25	-	-	±0.25	%FSS

<sup>1</sup> The temperature range over which the sensor will produce an output proportional to pressure within the specified performance limits. Note that for valid datasheet values, ambient and medium temperatures must be the same

<sup>2</sup> For the 10mbar differential sensor only, effective resolution is 11 bits at 15Hz and 10 bits at 1KHz

<sup>3</sup> The maximum deviation from ideal transfer function over the entire compensated temperature and pressure range. Includes all errors due to offset, full scale span, accuracy, thermal effect on offset, thermal effect on span and thermal hysteresis

<sup>4</sup> For the 10mbar differential sensor only, TEB is ±2.0% FSS for 0°C to +60°C and ±2.5% FSS for -20°C to +85°C

<sup>5</sup> The algebraic difference between the output signal measured at the maximum (P<sub>max</sub>) and the minimum (P<sub>min</sub>) limits of the pressure range

<sup>6</sup> The maximum deviation in output from a Best Fit Straight Line (BFSL) fitted to the output measured over the pressure range at 21°C [69.8°F]. Includes all errors due to pressure non-linearity, pressure hysteresis, non-repeatability and noise

<sup>7</sup> For the 10mbar differential sensor only, accuracy is ±1.5% FSS

<sup>8</sup> Accelerated Life Test Profile: 100hours at 90°C

#### 6. Temperature Sensor Operating Specifications

Characteristic	Min.	Typ.	Max.	Unit
Full Scale range	-20[-4]	-	+85[+185]	°C[°F]
Accuracy	-	0.5	-	°C
Resolution	14	-	-	bits
Output Rate	-	250	-	msec

## 7. Pressure Range Specifications (mbar)

Pressure Range	Pressure Range		Unit	Over Pressure <sup>1</sup>		Burst Pressure <sup>2</sup>		Common Mode Pressure <sup>3</sup>
	P <sub>min</sub>	P <sub>max</sub>		Port1 (P1)	Port 2 (P2)	Port1 (P1)	Port 2 (P2)	
Absolute								
00500MA	200	500	mbara	4000	-	4000	-	-
01000MA	200	1000	mbara	4000	-	4000	-	-
01250MA	200	1250	mbara	4000	-	4000	-	-
02000MA	200	2000	mbara	4000	-	4000	-	-
05000MA	200	5000	mbara	20000	-	20000	-	-
10000MA	200	10000	mbara	20000	-	20000	-	-
Gauge								
00060MG	0	60	mbarg	1000	-	5000	-	-
00100MG	0	100	mbarg	1000	-	5000	-	-
00160MG	0	160	mbarg	5000	-	5000	-	-
00250MG	0	250	mbarg	5000	-	5000	-	-
00400MG	0	400	mbarg	5000	-	5000	-	-
00600MG	0	600	mbarg	4000	-	21000	-	-
01500MG	0	1500	mbarg	4000	-	21000	-	-
05500MG	0	5500	mbarg	21000	-	21000	-	-
07000MG	0	7000	mbarg	21000	-	21000	-	-
11000MG	0	11000	mbarg	21000	-	21000	-	-
Differential								
00010MD	-10	10	mbarg	1000	1000	5000	2500	4000
00050MD	-50	50	mbarg	1000	1000	5000	2500	4000
00100MD	-100	100	mbarg	1000	1000	5000	2500	4000
00150MD	-150	150	mbarg	5000	2500	5000	2500	4000
00200MD	-200	200	mbarg	5000	2500	5000	2500	4000
00250MD	-250	250	mbarg	5000	2500	5000	2500	4000
00500MD	-500	500	mbarg	5000	2500	5000	2500	4000
00750MD	-750	750	mbarg	4000	2500	21000	2500	10000
01000MD	-1000	1000	mbarg	4000	2500	21000	2500	10000

<sup>1</sup> The maximum pressure which may safely be applied to the product for it to remain in specification once pressure is returned to the operating pressure range. Exposure to higher pressures may cause permanent damage to the product. Unless otherwise specified this applies to all available pressure ports at any temperature with the operating temperature range

### 7. Pressure Range Specifications (kPa)

Pressure Range	Pressure Range		Unit	Over Pressure <sup>1</sup>		Burst Pressure <sup>2</sup>		Common Mode Pressure <sup>3</sup>
	P <sub>min</sub>	P <sub>max</sub>		Port1 (P1)	Port 2 (P2)	Port1 (P1)	Port 2 (P2)	
Absolute								
00050KA	20	50	kPaA	400	-	400	-	-
00100KA	20	100	kPaA	400	-	400	-	-
00125KA	20	125	kPaA	400	-	400	-	-
00200KA	20	200	kPaA	400	-	400	-	-
00500KA	20	500	kPaA	2000	-	2000	-	-
01000KA	20	1000	kPaA	2000	-	2000	-	-
Gauge								
00006KG	0	6	kPaG	100	-	500	-	-
00010KG	0	10	kPaG	100	-	500	-	-
00016KG	0	16	kPaG	500	-	500	-	-
00025KG	0	25	kPaG	500	-	500	-	-
00040KG	0	40	kPaG	500	-	500	-	-
00060KG	0	60	kPaG	400	-	2100	-	-
00150KG	0	150	kPaG	400	-	2100	-	-
00550KG	0	550	kPaG	2100	-	2100	-	-
00700KG	0	700	kPaG	2100	-	2100	-	-
01100KG	0	1100	kPaG	2100	-	2100	-	-
Differential								
00001KD	-1	1	kPaG	100	100	500	250	400
00005KD	-5	5	kPaG	100	100	500	250	400
00010KD	-10	10	kPaG	100	100	500	250	400
00015KD	-15	15	kPaG	500	250	500	250	400
00020KD	-20	20	kPaG	500	250	500	250	400
00025KD	-25	25	kPaG	500	250	500	250	400
00050KD	-50	50	kPaG	500	250	500	250	400
00075KD	-75	75	kPaG	400	250	2100	250	1000
00100KD	-100	100	kPaG	400	250	2100	250	1000

<sup>2</sup>The maximum pressure that may be applied to the specified port (P1 or P2) of the product without causing escape of pressure media. Product should not be expected to function after exposure to any pressure beyond the burst pressure

## 7. Pressure Range Specifications (psi)

Pressure Range	Pressure Range		Unit	Over Pressure <sup>1</sup>		Burst Pressure <sup>2</sup>		Common Mode Pressure <sup>3</sup>
	P <sub>min</sub>	P <sub>max</sub>		Port1 (P1)	Port 2 (P2)	Port1 (P1)	Port 2 (P2)	
Absolute								
00010PA	2.9	10	psia	58	-	58	-	-
00015PA	2.9	15	psia	58	-	58	-	-
00020PA	2.9	20	psia	58	-	58	-	-
00030PA	2.9	30	psia	58	-	58	-	-
00075PA	2.9	75	psia	290	-	290	-	-
00145PA	2.9	145	psia	290	-	290	-	-
Gauge								
00001PG	0	1	psig	14.5	-	14.5	-	-
00002PG	0	2	psig	14.5	-	14.5	-	-
00003PG	0	3	psig	72.5	-	72.5	-	-
00004PG	0	4	psig	72.5	-	72.5	-	-
00005PG	0	5	psig	72.5	-	72.5	-	-
00010PG	0	10	psig	58	-	58	-	-
00020PG	0	20	psig	58	-	58	-	-
00080PG	0	80	psig	304.6	-	304.6	-	-
00100PG	0	100	psig	304.6	-	304.6	-	-
00160PG	0	160	psig	304.6	-	304.6	-	-
Differential								
00001PD	-1	1	psig	14.5	14.5	72.5	36.3	58
00002PD	-2	2	psig	14.5	14.5	72.5	36.3	58
00003PD	-3	3	psig	14.5	14.5	72.5	36.3	58
00004PD	-4	4	psig	72.5	36.3	72.5	36.3	58
00005PD	-5	5	psig	72.5	36.3	72.5	36.3	58
00006PD	-6	6	psig	72.5	36.3	72.5	36.3	58
00007PD	-7	7	psig	72.5	36.3	72.5	36.3	58
00010PD	-10	10	psig	58	36.3	304.6	36.3	145
00015PD	-15	15	psig	58	36.3	304.6	36.3	145

<sup>3</sup> Common mode pressure: The maximum pressure that can be applied simultaneously to both ports of a differential pressure sensor without causing changes in specified performance. Note that pressure should firstly be applied to (P1).

## Datasheet ESCP-BMS1

### 8. Wetted Materials<sup>1</sup>

Component	Pressure Port1 (P1) Dry Gas	Pressure Port2 (P2) Dry Gas
Ports and covers	Liquid Crystal Polymer	
Substrate	Alumina Ceramic Al <sub>2</sub> O <sub>3</sub>	
Adhesives	Epoxy or silicone based	Epoxy or silicone based
Electronic components	Silicon, glass, solder, gold, aluminum, ceramic, silver	Silicon

<sup>1</sup> Contact ES Systems Customer Service for detailed material information

### 9. Pinouts

Output	PIN1	PIN2	PIN3	PIN4	PIN5	PIN6	PIN7	PIN8
I <sup>2</sup> C	Int Sel <sup>1</sup>	VDD	SDA	SCL	NC <sup>2</sup>	NC	NC	GND
SPI	Int Sel <sup>1</sup>	VDD	MOSI	SCLK	NC	CS	MISO	GND
Analog	NC	VDD	NC	NC	Aout	NC	NC	GND

<sup>1</sup> Interface select. Tie to VDD for I<sup>2</sup>C communication or GND for SPI communication

<sup>2</sup> Do not Connect

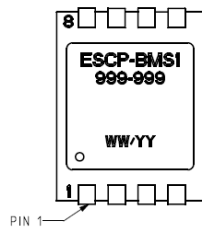

### 10. Environmental Specifications

Characteristic	Parameter
Vibration	15g, 10Hz to 2 kHz
Shock	100g, 6ms duration
ESD	ESD JS-001-2014 HBM ±1kV
Shelf Life	20 years
Life <sup>1</sup>	1 million pressure cycles minimum
Soldering time and temperature:	

<sup>1</sup> Life may vary depending on specific application in which the sensor is used



## 11. Data & Register Description

The sensor outputs a 32 bit calibrated pressure output of the pressure range in calibration units. The 32 bit register is a signed fixed point integer and is organized as follows. The 32 bit register consists of four 8 bit registers in consecutive addresses. The calibrated pressure value starts at address 0x40 and ends at address 0x43. The sensor allows for address autoincrement hence the user only needs to request data from the initial address (in this case 0x40) and then perform continuous reads for the remaining bytes of the 32 bit value. Data comes most significant bit first, least significant byte first (little endian). The calibrated temperature value starts at address 0x44 and ends at address 0x47. The same as pressure value data comes out most significant bit first, least significant byte first (little endian).

The register organization is presented below:

### Calibrated Pressure:

ADDRESS	REGISTER NAME	TYPE	DEFAULT VALUE (Hex)	MNEMONIC
0x40	Calibrated Pressure Byte 1	R	Variable	CAL_PRESS_DATA[7:0]
	Calibrated Pressure Byte 2	R	Variable	CAL_PRESS_DATA[15:8]
	Calibrated Pressure Byte 3	R	Variable	CAL_PRESS_DATA[23:16]
	Calibrated Pressure Byte 4	R	Variable	CAL_PRESS_DATA[31:24]

To convert reading into pressure:

$$Pressure(calib\ units) = \frac{32bit\ integer\ value}{2^{22}}$$

### Calibrated Temperature:

ADDRESS	REGISTER NAME	TYPE	DEFAULT VALUE (Hex)	MNEMONIC
0x44	Calibrated Temperature Byte 1	R	Variable	CAL_TEMP_DATA[7:0]
	Calibrated Temperature Byte 2	R	Variable	CAL_TEMP_DATA[15:8]
	Calibrated Temperature Byte 3	R	Variable	CAL_TEMP_DATA[23:16]
	Calibrated Temperature Byte 4	R	Variable	CAL_TEMP_DATA[31:24]

To convert reading into temperature:

$$Temperature(^{\circ}C) = \frac{32bit\ integer\ value}{2^{22}}$$

### Data Register Reading Process

The process that the user must follow to read the data from BMS1 device is very similar in both I<sup>2</sup>C and SPI interfaces. As described in the previous sections the user must first address the register to be read and then read sequentially all the data bytes. After powering for the user to be able to read valid data the conversions must be started. This is realized by sending the command (**0x8C**) with no payload. This command puts the device in read-triggered mode meaning that at the end of every data read transaction (single or multi read) the device starts a new pressure and temperature conversion the data of which can be retrieved at the next read transaction.

In case of I<sup>2</sup>C interface device the readout process for pressure is presented below:

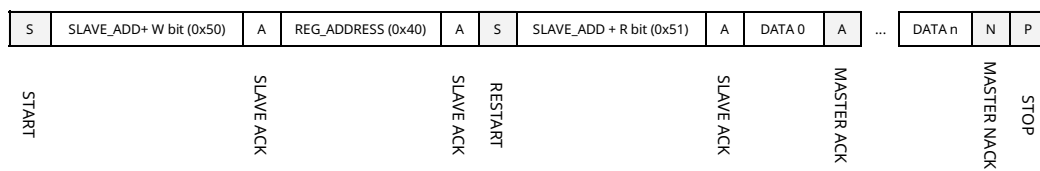

In case of an SPI interface device the same pressure readout is presented below:

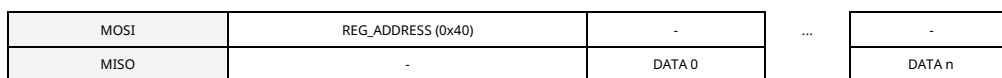

For temperature reading the readout process is identical with different register address (0x44). Also the user can make use of the multi read feature to read both calibrated pressure and calibrated temperature values in one transaction both in I<sup>2</sup>C or SPI mode. To realize this transaction the MCU must start reading register (0x40) and not stop after the readout of the calibrated pressure values (4bytes) but continue reading the next 4 bytes. The last 4 bytes are the calibrated temperature value as described in the previous section.

If the user performs a read transaction other than reading temperature and pressure data (eg serial number) the conversions automatically stop and need to be restarted from the user.

### Serial Number Reading Process

Like data readout, serial number readout is the same for both I<sup>2</sup>C and SPI interfaces. Unlike data readout the serial number is located at a different memory and the readout process is somewhat different than the data readout. In this case the user must write the 2 byte command (0x238A) to the device after the slave address (0x50). After the command is sent the user can read the 7 bytes of the serial number and translate them as described below:

ADDRESS	BYTE NAME	TYPE	DEFAULT VALUE (Hex)	MNEMONIC
-	Product Family Code Byte 1	R	Fixed ID	PFC[7:0]
	Product Family Code Byte 2	R	Fixed ID	PFC[15:8]
	Product code Byte 1	R	Fixed ID	PC[7:0]
	Product code Byte 2	R	Fixed ID	PC[15:8]
	Lot number	R	Fixed ID	LN [7:0]
	Serial number 1	R	Fixed ID	SN[7:0]
	Serial number 2	R	Fixed ID	SN[15:8]

The serial number consists of 4 parts: [Product Family Code]-[Product Code] [Lot number]-[Serial Number].

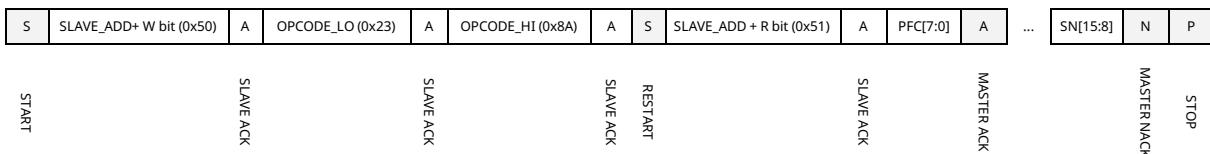

For example the serial number 0x8803530104001C translates to: 904-339 04-0028

## 12. I<sup>2</sup>C Interface

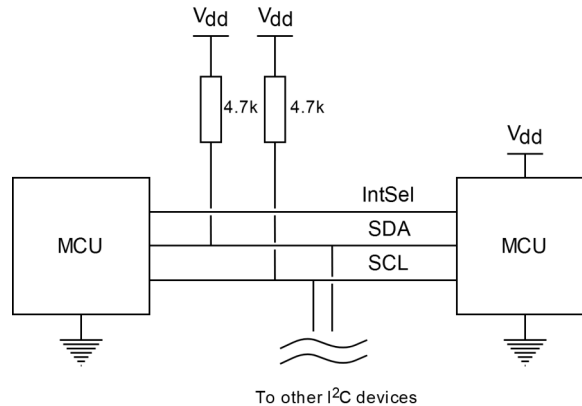

The sensors obey the full I<sup>2</sup>C protocol standard with the difference that they operate up to SCL (I<sup>2</sup>C Clock) speeds of 100 kHz. The sensors support clock stretching functionality. If the device is not ready to transmit data, holds the clock (SCL) line low and releases it once it is ready. The master must consider this condition and either identify it and wait until the clock is released or exit with a repeated start condition.

The sensor can operate with single read or single write transactions as well as multi read transactions. For data readout the multi read transaction is highly recommended as it ensures data integrity. The sensors allow for register address auto increment starting from the first address definition.

In order to ensure data integrity when the BMS1 device is connected to a multi-slave I<sup>2</sup>C bus, the user must drive IntSel pin low when communicating with other devices other than the BMS1. When the user wants to communicate with the BMS1 device he must drive IntSel pin high.

### **I<sup>2</sup>C Specification**

Both signals (SCL and SDA) are bidirectional. They are connected via resistors to a positive power supply voltage. This means that when the bus is free, both lines are high. All devices on the bus must have open-collector or open-drain pins. Activating the line means pulling it down. The number of the devices on a single bus is limited to 127 and the only requirement is that the bus capacitance does not exceed 400pF. For each clock pulse one bit of data is transferred. The SDA signal can only change when the SCL signal is low – when the clock is high the data should be stable.

Each I<sup>2</sup>C command initiated by a master device starts with a START condition and ends with a STOP condition. For both conditions SCL has to be high. A high to low transition of SDA is considered as START and a low to high transition as STOP.

After the Start condition the bus is considered as busy and can be used by another master only after a Stop condition is detected. After the Start condition the master can generate a repeated Start. This is equivalent to a normal Start and is followed by the slave I<sup>2</sup>C address.

Microcontrollers that have dedicated I<sup>2</sup>C hardware can easily detect bus changes and behave also as I<sup>2</sup>C slave devices. However, if the I<sup>2</sup>C communication is implemented in software, the bus signals must be sampled at least two times per clock cycle in order to detect necessary changes.

Data on the I<sup>2</sup>C bus is transferred in 8-bit packets (bytes). There is no limitation on the number of bytes, however, each byte must be followed by an Acknowledge bit. This bit signals whether the device is ready to proceed with the next byte. For all data bits including the Acknowledge bit, the master must generate clock pulses. If the slave device does not acknowledge the transfer this means that there is no more data, or the device is not ready for the transfer yet. The master device must either generate Stop or Repeated Start condition.

Each slave device on the bus should have a unique 7-bit address. The communication starts with the Start condition, followed by the 7-bit slave address and the data direction bit. If this bit is 0 then the master will write to the slave device. Otherwise, if the data direction bit is 1, the master will read from slave device. After the slave address and the data direction is sent, the master can continue with reading or writing. The communication is ended with the Stop condition which also signals that the I<sup>2</sup>C bus is free. If the master needs to communicate with other slaves, it can generate a repeated start with another slave address without generation Stop condition. All the bytes are transferred with the MSB bit shifted first.

A general I<sup>2</sup>C communication diagram is shown below:

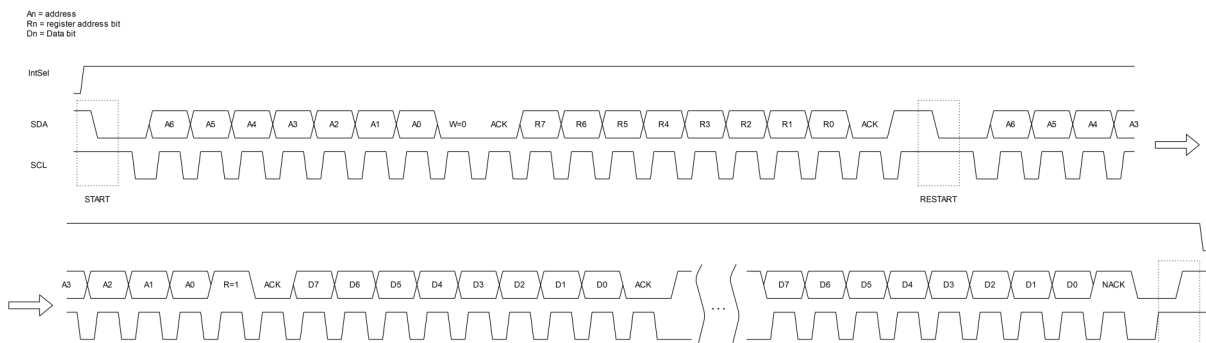

I<sup>2</sup>C read diagram

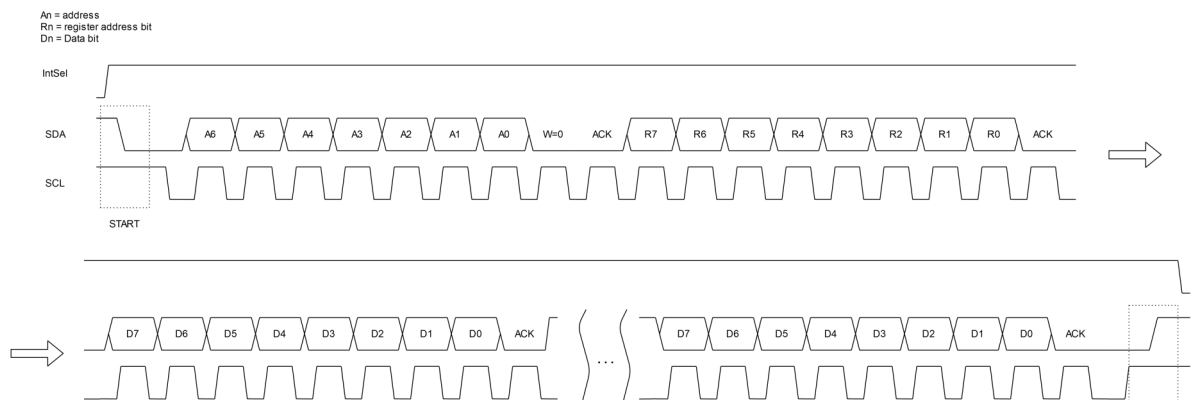

I<sup>2</sup>C write diagram

### I<sup>2</sup>C Slave address

The sensor is factory programmed with the default 7 bit slave address of 0x28. The end user only needs to program the R/W bit that corresponds to the direction of communication as shown below.

MSB							LSB
0	1	0	1	0	0	0	R/W

Hence for write transactions the salve address byte is 0x50 and for read transactions the slave address byte is 0x51. Slave address is shifted left one and the R/W bit appended.

The sensor supports SCL clock frequencies up to 100 kHz.

### I<sup>2</sup>C communication example

A typical use case is presented bellow. The user powers up the ESCP-BMS1 either by applying power to the system. After initializing, the user reads the device’s serial number, initiates sensor conversions and reads the pressure and temperature values periodically. If the user reads anything other than calibrated pressure or temperature the conversion start command needs to be sent again. The readout of serial number is optional step but it is essential to clarify that if the user interrupts the sample reading loop the “start conversions” command must be issued before any attempt to read pressure or temperature.

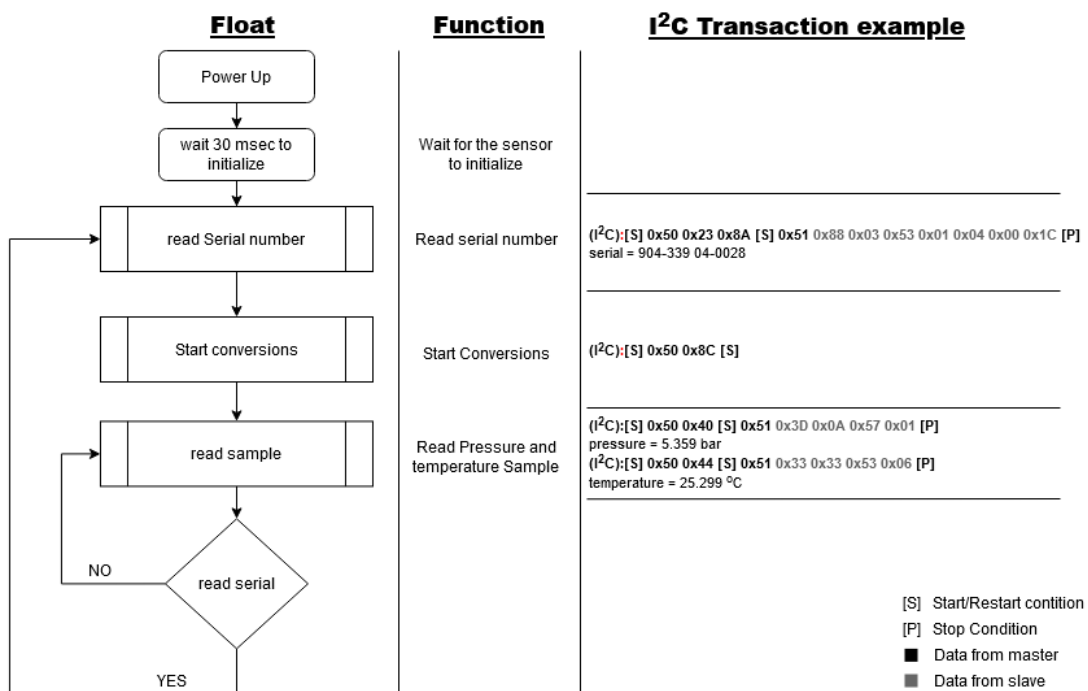

### 13. SPI Interface

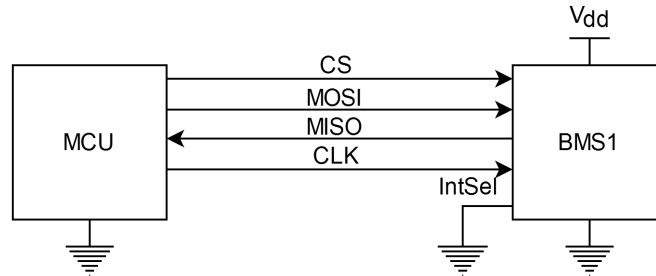

The sensor can communicate with two different serial interfaces, I<sup>2</sup>C and SPI (only one at the same time). The interface select pin selects which interface is active. Pulling the interface select pin high enables I<sup>2</sup>C interface whereas pulling it low enables SPI interface. In this document the SPI interface is described hence the interface select pin must be pulled low to operate in this mode.

The sensor obeys the full SPI protocol standard. The SPI specifications are depicted in the following tables.

SPI Parameter	Description	Setting
<b>CPOL</b>	Clock Polarity	0
<b>CPHA</b>	Clock Phase	1
<b>Mode</b>	SPI Mode	1
<b>DORD</b>	Bit Sequence order	0, MSB

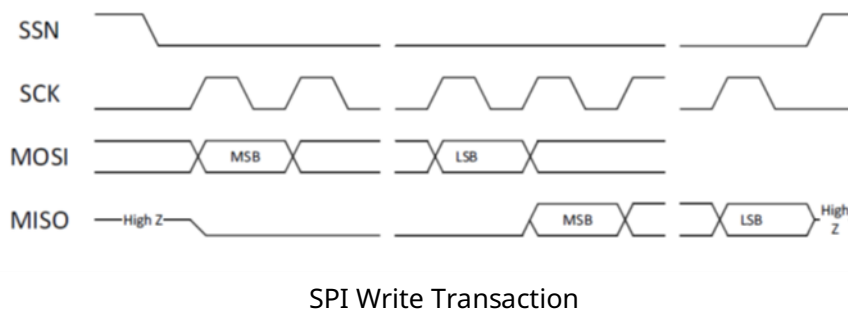
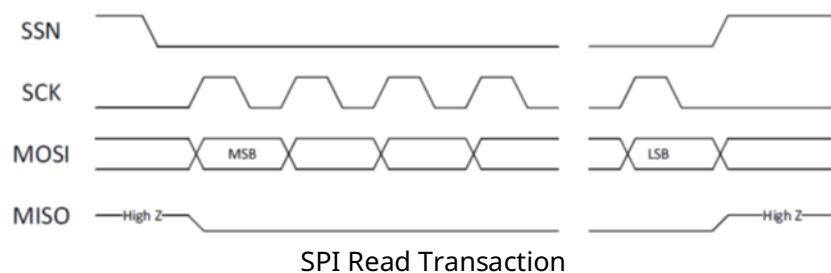

The timing specification of the SPI interface for the device are depicted in the following table:

Timing Parameter	Value	Units
Serial Clock Frequency	1	MHz
Serial Clock Pulse width HI state	500	ns
Serial Clock Pulse width LOW state	500	ns
CS enable-to-valid latch	150	ns
CS pulse width between write cycles	500	ns
Data setup time prior to clock edge	100	ns
Data hold time after clock edge	100	ns
Data valid after clock edge	100	ns

The sensor can operate with single read or single write transactions as well as multi read and multi write transactions. For data readout a multi read transaction is highly recommended as it ensures data integrity. The sensor allows for register address auto increment starting from the first address definition.

After the CS change from HI to LOW the master (MCU) should transmit the register address that want to address. After the addressing the BMS1 device will shift the contents of the register addressed at every clock cycle. After the completion of a full byte transfer the BMS1 device will continue to shift the data of the next register thus realizing the auto increment functionality.

In the diagram below a transaction example is shown:

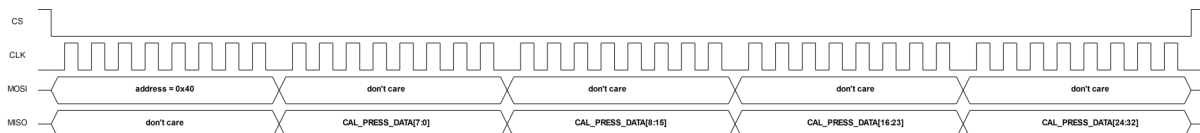



### SPI communication example

A typical use case is presented bellow. The user powers up the ESCP-BMS1 either by applying power to the system. After initializing, the user reads the device's serial number, initiates sensor conversions and reads the pressure and temperature values periodically. If the user reads anything other than calibrated pressure or temperature the conversion start command needs to be sent again. The readout of serial number is optional step but it is essential to clarify that if the user interrupts the sample reading loop the "start conversions" command must be issued before any attempt to read pressure or temperature.

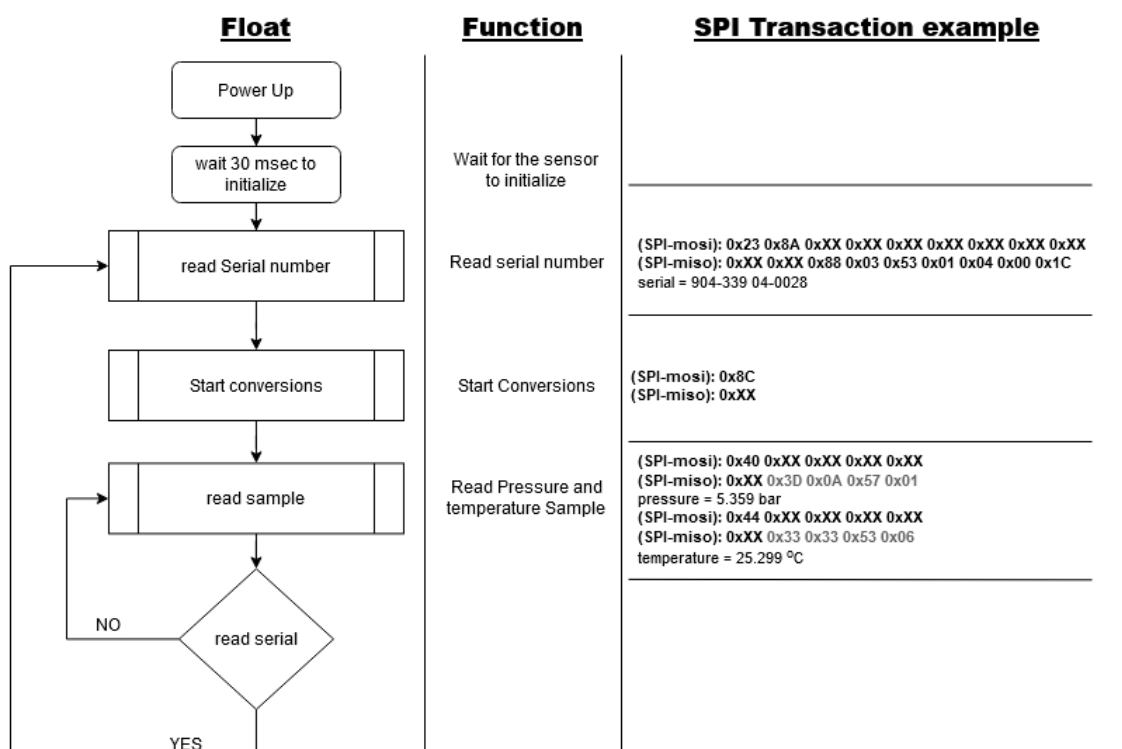

0xXX = don't care

### 15. Analog Interface

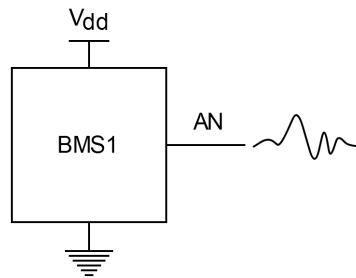

Similar to the PWM versions the analog version of the BMS1 device outputs an output voltage ranging from 0 to Vdd according to the calibrated pressure measured. The output is not buffered so the output is a high impedance signal of several hundreds Kohms and the user must take this in to consideration as the load can distort the signal.

The characteristics of the analog output are described in the table below:

	Value	Unit
Vout min	0	V
Vout max	Vdd	V
Response time (10%-90%)	Depends on specified conversion rate and load capacitance	
V ripple	<10	mV p-p
Output impedance	220	kohm

The pressure output is proportional to the voltage and is calculated from the equation below:

$$Pressure(calib\ units) = \frac{V_{out}}{V_{dd}}(P_{max} - P_{min}) + P_{min}$$

**16. Mechanical Drawings (mm)**

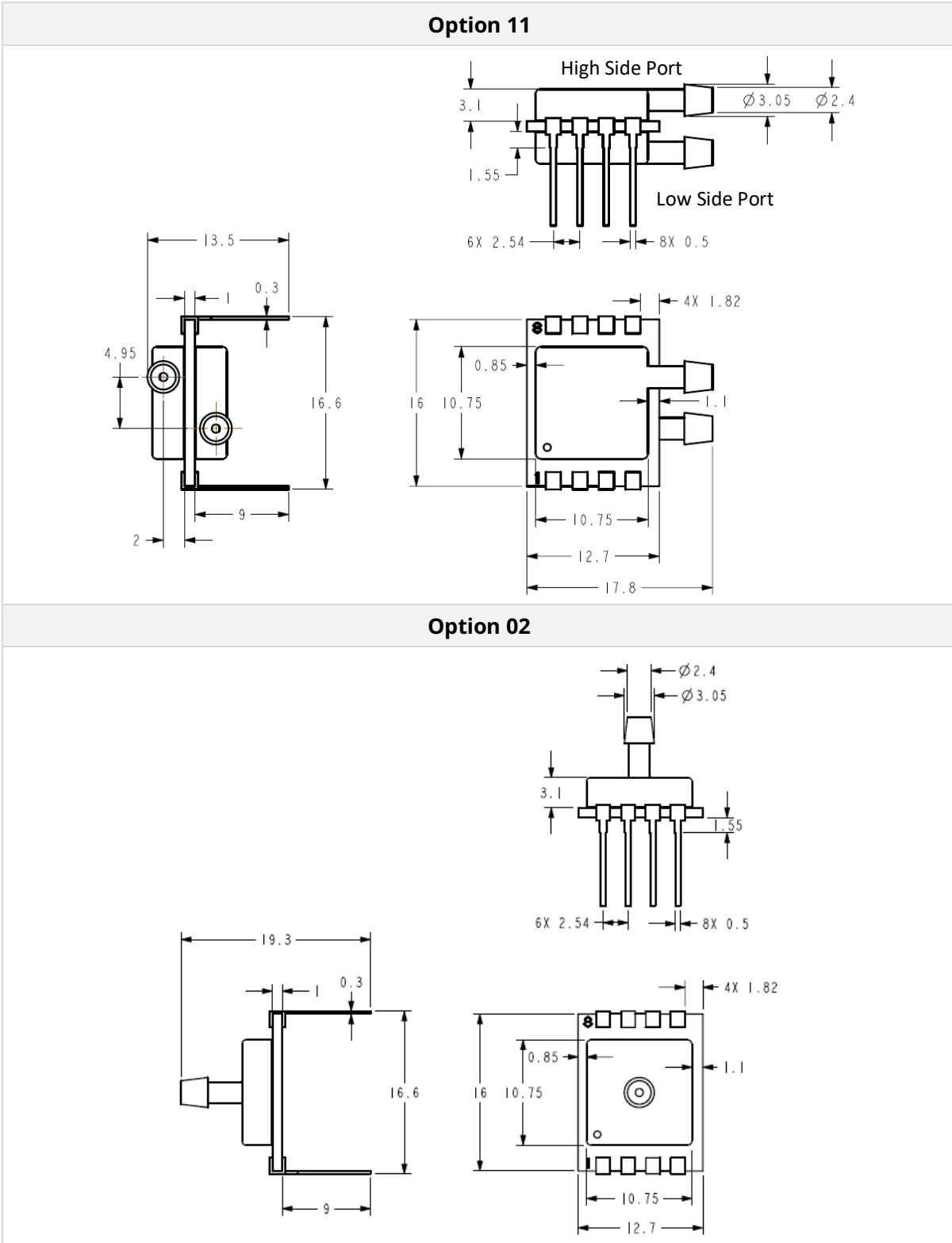

**16. Mechanical Drawings (mm)**

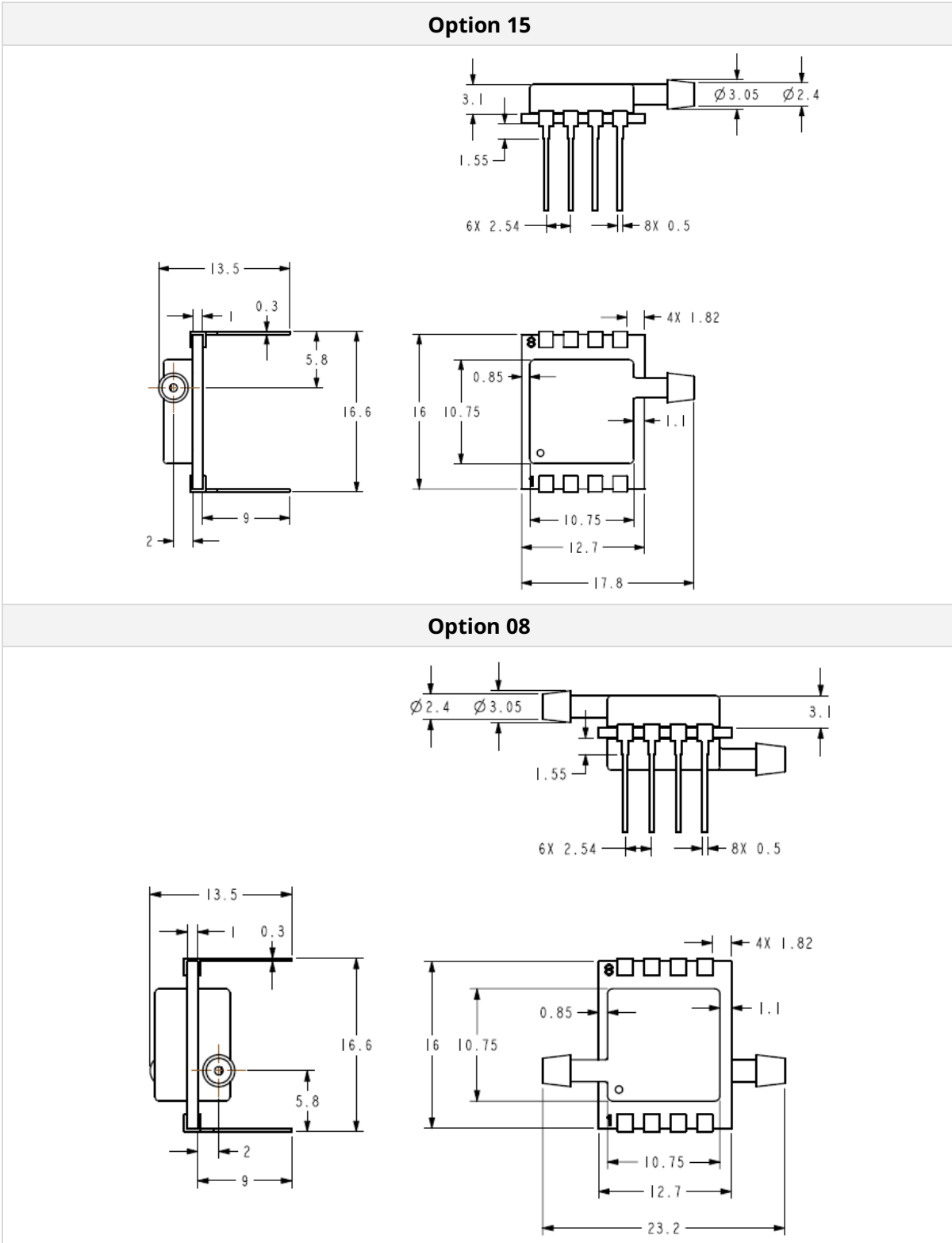

### 17. PCB Layout (All dimensions in mm)

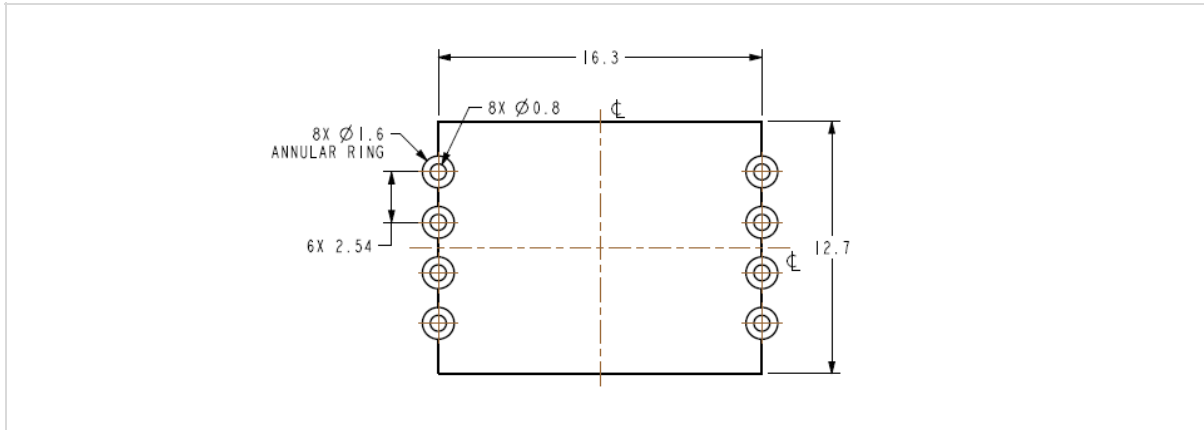

### 18. Instructions of Mounting

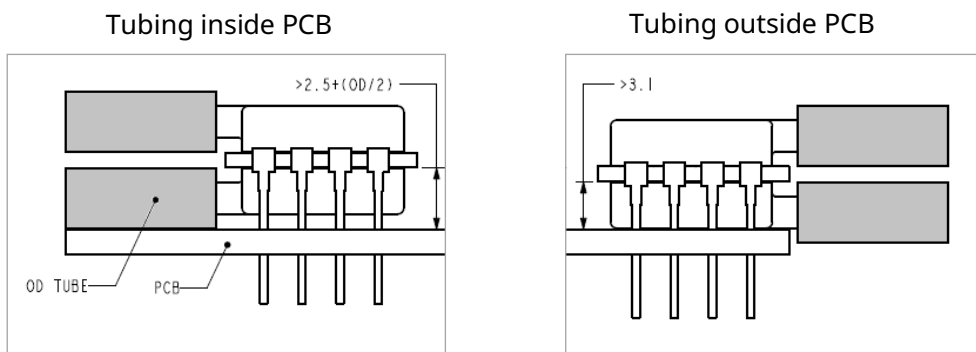

For optimal performance, ensure that the ESCP-BMS1 sensor is correctly mounted to the PCB as illustrated in the figures above. No mechanical stress should be applied to the sensor during or following its installation. The suggested internal diameter for the tubes is 2.5 mm.

### 19. Instructions of Operation

The ESCP-BMS1 sensor features digital temperature compensation. The temperature is measured on the MEMS element by an on-chip temperature sensor. This data is fed to a compensation circuit that is also integrated on the microprocessor. Thus, no external temperature compensation is necessary.

#### **Sensor Handling**

The ESCP-BMS1 sensor is designed to be robust and shock resistant. Nevertheless, the accuracy of the high-precision ESCP-BMS1 can be degraded by rough handling. ES Systems does not guarantee proper operation in case of improper handling.

## 20. Ordering Information

### ESCP-BMS1-N-NNNNNNN-NN-NN-NN-N-N

#### Media

G Dry gases only

#### Pressure Range

Absolute	Gauge	Differential
00500MA	00060MG	00010MD
01000MA	00100MG	00050MD
01250MA	00160MG	00100MD
02000MA	00250MG	00150MD
05000MA	00400MG	00200MD
10000MA	00600MG	00250MD
00050KA	01500MG	00500MD
00100KA	05500MG	00750MD
00125KA	07000MG	01000MD
00200KA	11000MG	00001KD
00500KA	00006KG	00005KD
01000KA	00010KG	00010KD
00010PA	00016KG	00015KD
00015PA	00025KG	00020KD
00020PA	00040KG	00025KD
00030PA	00060KG	00050KD
00075PA	00150KG	00075KD
00145PA	00550KG	00100KD
	00700KG	00001PD
	01100KG	00002PD
	00001PG	00003PD
	00002PG	00004PD
	00003PG	00005PD
	00004PG	00006PD
	00005PG	00007PD
	00010PG	00010PD
	00020PG	00015PD
	00080PG	
	00100PG	
	00160PG	

#### Temperature Sensor

Y Yes  
N No

#### Pressure Response Time

1 15Hz  
2 1kHz

#### Compensated Temperature

01 0°C to 60°C  
02 -20°C to 85°C

#### Pressure Port

11

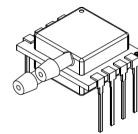

02

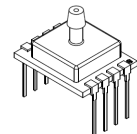

15

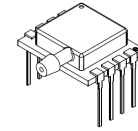

08

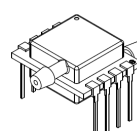

#### Output Type

01 SPI / I<sup>2</sup>C (address 0x28) 05 Analog  
02 SPI / I<sup>2</sup>C (address 0x29)  
03 SPI / I<sup>2</sup>C (address 0x2A)  
04 SPI / I<sup>2</sup>C (address 0x2B)

## Important Notes

### **PERSONAL INJURY**

**DO NOT USE these products as safety or emergency stop devices, or in any other application where failure of the product could result in personal injury.**

Failure to comply with these instructions could result in death or serious injury.

### **WARRANTY**

ES Systems warrants this Product to be free of defects in materials and workmanship for a period of one (1) year from the date of purchase.

Upon examination by ES Systems, if the unit is found to be defective it will be repaired or replaced at no charge. ES Systems' WARRANTY does not apply to defects resulting from any action of the purchaser, including but not limited to mishandling, improper interfacing, operation outside of design limits, improper repair, or unauthorized modification. This WARRANTY is VOID if the unit shows evidence of having been tampered with or shows evidence of being damaged as a result of excessive corrosion; or current, heat, moisture or vibration; improper specification; misapplication; misuse or other operating conditions outside of ES Systems' control. Components which wear are not warranted.

ES Systems neither assumes responsibility for any omissions or errors nor assumes liability for any damages that result from the use of its Product in accordance with information provided by ES Systems, either verbal or written. ES Systems warrants only that the parts manufactured by it will be as specified and free of defects.

**ES SYSTEMS MAKES NO OTHER WARRANTIES OR REPRESENTATIONS OF ANY KIND WHATSOEVER, EXPRESSED OR IMPLIED, EXCEPT THAT OF TITLE, AND ALL IMPLIED WARRANTIES INCLUDING ANY WARRANTY OF MERCHANTABILITY AND FITNESS FOR A PARTICULAR PURPOSE ARE HEREBY DISCLAIMED.**

No representative of ES Systems is authorized to extend this Warranty or to change it in any manner whatsoever.

No warranty applies to any party other than the original Customer. The remedies of the Customer set forth herein are exclusive and the total liability of ES Systems with respect to this order, whether based on contract, warranty, negligence, indemnification, strict liability or otherwise, shall not exceed the purchase price of the component upon which liability is based.

In no event shall ES Systems be liable for consequential, incidental or special damages.

Specifications may change without notice. The information supplied is believed to be accurate and reliable as of this issue; however, ES Systems assumes no responsibility for its use.

## Contact Information

### **ES Systems S.A.**

#### **Head Office:**

7, Stratigi St., GR-154 51  
Neo Psychico, Greece  
Tel: (+30) 210 672 8610,  
Fax (+30) 210 672 8624

#### **Factory:**

57, I.Metaxa str., GR-194 41  
Koropi, Greece  
Tel: (+30) 216 2000 500,  
Fax (+30) 216 2000 555